

MODELS CSTC, CSRTD, CSINI, CSINV - MODULAR CONTROLLER SERIES ANALOG INPUT MODULES

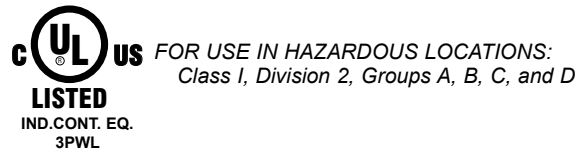

- DEDICATED HIGH DENSITY INPUT MODULES FOR THE MODULAR CONTROLLER SERIES
- MODELS AVAILABLE TO ACCEPT ± 10 V, 0/4-20 mA, THERMOCOUPLE AND RTD INPUTS
- ± 10 V AND 0/4-20 mA INPUT VERSIONS FULLY SCALABLE
- ± 10 V AND 0/4-20 mA INPUT VERSIONS AVAILABLE WITH 100 POINT LINEARIZATION
- UNUSED INPUTS CAN BE DISABLED TO INCREASE OVERALL READING RATE
- IDEAL FOR DATA-ACQUISITION APPLICATIONS
- AUTO ADDRESSING MINIMIZES CONFIGURATION TIME
- CAN BE USED IN CONJUNCTION WITH ANY CS SERIES MODULES



GENERAL DESCRIPTION

The Model CSTC, CSRTD, CSINI, and CSINV are 16-bit analog input modules designed for use with the Modular Controller Series. These modules provide a means of high-density signal measurement for data-acquisition applications. The CSTC module accepts a wide range of thermocouple types, while the CSRTD accepts various RTD inputs. The CSINI and CSINV accept 0/4-20 mA and ± 10 V process signals, respectively.

The modules connect and communicate via a backplane connection to the CSMSTR Modular Controller Series Master. The CSMSTR, equipped with serial ports as well as an Ethernet port, allows the system to share data with PCs, PLCs, and SCADA systems. The Master supports any combination of up to 16 CS series modules, allowing a total of 128 signals to be monitored via a single Master.

Internal power management circuits allow the modules to be replaced while power is applied, which reduces downtime. All configuration information is stored locally within the module, as well as in the Master, so replacement modules do not need to be configured.

The Modular Controller Series' high density packaging and DIN rail mounting saves time and panel space. The backplane connection provides power and communication to the module and snaps easily onto standard top hat (T) profile DIN rail.

CONFIGURATION

The Modular Controller Series is configured with Windows® compatible Crimson® software. The software is an easy to use, graphical interface which provides a means of configuration and commissioning of new systems, as well as routine module re-calibration.

SAFETY SUMMARY

All safety related regulations, local codes and instructions that appear in the manual or on equipment must be observed to ensure personal safety and to prevent damage to either the instrument or equipment connected to it. If equipment is used in a manner not specified by the manufacturer, the protection provided by the equipment may be impaired.

Do not use the module to directly command motors, valves, or other actuators not equipped with safeguards. To do so can be potentially harmful to persons or equipment in the event of a fault to the module. An independent and redundant temperature limit indicator with alarm outputs is strongly recommended.

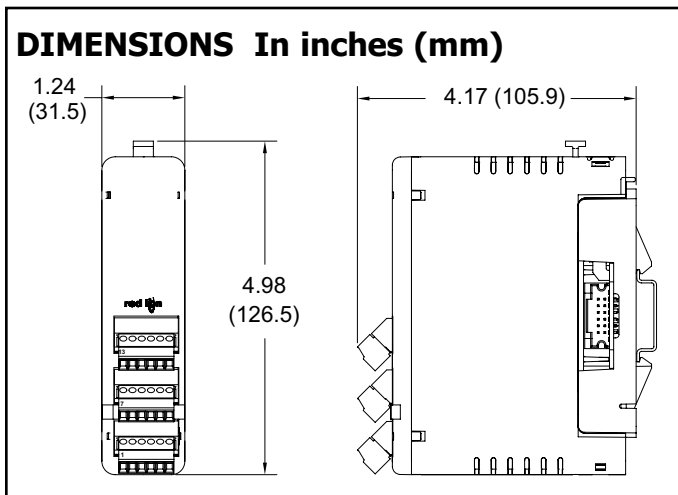





CAUTION: Risk of Danger.
Read complete instructions prior to installation and operation of the unit.



CAUTION: Risk of electric shock.

-  **WARNING - EXPLOSION HAZARD - SUBSTITUTION OF COMPONENTS MAY IMPAIR SUITABILITY FOR CLASS I, DIVISION 2**
-  **THIS EQUIPMENT IS SUITABLE FOR USE IN CLASS I, DIVISION 2, GROUPS A, B, C, D, OR NON-HAZARDOUS LOCATIONS ONLY**

GENERAL SPECIFICATIONS

- POWER:** Derived from system backplane. (75 mA load on power input of MASTER). Module may be hot-swapped (replaced while powered up).
- LEDs:**
 - STS** - Status LED shows module condition.
 - ALM** - Alarm LED is lit during any internal alarm condition.
- MEMORY:** Non-volatile memory retains all programmable parameters. MASTER also stores the parameters in order to reprogram modules that are replaced.
- ISOLATION LEVEL:** 500 Vrms @ 50/60 Hz for 1 minute between the Signal Inputs and the CS Master Power Supply Input.
- COMMUNICATIONS:** Provided by the CS Master
- CERTIFICATIONS AND COMPLIANCES:**

SAFETY

Check each module's specifications to determine system compliance.

CE Approved

EN 61326-1 Immunity to Industrial Locations
Emission CISPR 11 Class A

Safety requirements for electrical equipment for measurement, control, and laboratory use:

EN 61010-1: General Requirements
EN 61010-2-030: Particular Requirements for Testing and Measuring Circuits

EN 61010-2-201: Particular Requirements for Control Equipment

RoHS Compliant

UL Listed: File #E302106

UL Hazardous: File #E317425

ABS Certificate #09-HS426719-B-4-PDA

7. ENVIRONMENTAL CONDITIONS:

Operating Temperature Range: 0 to +50 °C

Storage Temperature Range: -40 to +85 °C

Operating and Storage Humidity: 85% max relative humidity, non-condensing, from 0 to +50 °C

Vibration to IEC 68-2-6: Operational 10 to 150 Hz, 1 g.

Shock to IEC 68-2-27: Operational 25 g.

Altitude: Up to 2000 meters

- CONSTRUCTION:** Case body is burgundy high impact plastic. For indoor use only. Installation Category II, Pollution Degree 2.

- CONNECTIONS:** Removable wire clamp screw terminal blocks

Wire Gage: 28-16 AWG terminal gage wire

Torque: 1.96-2.23 inch/lbs (0.22-0.25 N-m)

- MOUNTING:** Snaps on to standard DIN style top hat (T) profile mounting rails according to EN50022 -35 x 7.5 and -35 x 15.

- WEIGHT:** 6 oz (170.1 g)



WARNING - EXPLOSION HAZARD - DO NOT DISCONNECT EQUIPMENT UNLESS POWER HAS BEEN SWITCHED OFF OR AREA IS KNOWN TO BE NON-HAZARDOUS.

CSTC8 SPECIFICATIONS

12. INPUTS:

Channels: 8 single-ended

Effective Resolution: Full 16-bit

Sample Time: 50 msec - 400 msec, depending on number of enabled inputs.

ENABLED INPUTS	SCAN TIME (READING RATE)
1	50 msec (20 Hz)
2	100 msec (10 Hz)
3	150 msec (6.7 Hz)
4	200 msec (5 Hz)
5	250 msec (4 Hz)
6	300 msec (3.3 Hz)
7	350 msec (2.9 Hz)
8	400 msec (2.5 Hz)

Common Mode Rejection: >110 dB, 50/60 Hz

Normal Mode Rejection: >90 dB, 50/60 Hz

Temperature Coefficient: 0.01%/°C

Step Response Time: One scan time (to within 99% of final value)

Types: T, E, J, K, R, S, B, N, C

Slope & Offset: Provides sensor error correction

Input Impedance: 20 M Ω

Lead Resistance Effect: 0.25 μV/Ω

Cold Junction Compensation: Less than ±1 °C typical (±1.5 °C max) over 0 to 50 °C ambient temperature

Resolution: 0.1°

TYPE	MEASUREMENT RANGE	WIRE COLOR	
		ANSI	BS 1843
T	-200 to +400 °C -328 to +752 °F	(+) Blue (-) Red	(+) White (-) Blue
E	-200 to +730 °C -328 to +1346 °F	(+) Violet (-) Red	(+) Brown (-) Blue
J	-200 to +760 °C -328 to +1400 °F	(+) White (-) Red	(+) Yellow (-) Blue
K	-200 to +1350 °C -328 to +2462 °F	(+) Yellow (-) Red	(+) Brown (-) Blue
R	0 to +1768 °C +32 to +3214 °F	No Standard	(+) White (-) Blue
S	0 to +1768 °C +32 to +3214 °F	No Standard	(+) White (-) Blue
B	+149 to +1820 °C +300 to +3308 °F	No Standard	No Standard
N	-200 to +1300 °C -328 to +2372 °F	(+) Orange (-) Red	(+) Orange (-) Blue
C W5/W6	0 to +2315 °C +32 to +4199 °F	No Standard	No Standard
Millivolt	-10.00 to +56.00 mV	No Standard	No Standard

- TEMPERATURE INDICATION ACCURACY:** ± (0.3% of span, +1 °C). Includes NIST conformity, cold junction effect, A/D conversion errors, temperature coefficient and linearization conformity at 23 °C after 20 minute warm up.
- PROBE BREAK RESPONSE:** Upscale drive, Input Fault Alarm bit set high, ALM LED illuminates.

CSRTD6 SPECIFICATIONS

15. RTD INPUTS:

Channels: 6 single-ended

Effective Resolution: Full 16-bit

Sample Time: 67 msec - 400 msec, depending on enabled inputs.

ENABLED INPUTS	SCAN TIME (READING RATE)
1	67 msec (14.9 Hz)
2	133 msec (7.5 Hz)
3	200 msec (5 Hz)
4	267 msec (3.8 Hz)
5	333 msec (3 Hz)
6	400 msec (2.5 Hz)

Common Mode Rejection: >110 dB, 50/60 Hz

Normal Mode Rejection: >90 dB, 50/60 Hz

Temperature Coefficient: 0.01%/°C

Step Response Time: One scan time (to within 99% of final value)

Type: 2 or 3 wire

Excitation: 150 μ A

Lead Resistance: 15 Ω Max

Resolution: 0.1°

Slope & Offset: Provides sensor error correction

TYPE	INPUT TYPE	RANGE	ACCURACY 18 TO 28°C	ACCURACY 0 TO 50°C
385	100 Ω platinum, Alpha = .00385	-200 to +600 °C -328 to +1100 °F	\pm (0.1% of span)	\pm (0.2% of span)
392	100 Ω platinum, Alpha = .003919	-200 to +600 °C -328 to +1100 °F	\pm (0.1% of span)	\pm (0.2% of span)
672	120 Ω nickel, Alpha = .00672	-80 to +215 °C -112 to +419 °F	\pm (0.1% of span)	\pm (0.2% of span)
Ohms	Linear resistance	0 Ω to 300 Ω	\pm (0.1% of span)	\pm (0.2% of span)
428	50 Ω copper, Alpha = .00428	-50 to +200 °C -58 to +392 °F	\pm (0.6% of span)	\pm (1.2% of span)

16. **TEMPERATURE INDICATION ACCURACY:** Includes NIST conformity, A/D conversion errors, temperature coefficient and linearization conformity at 23 °C after 20 minute warm up.

17. **PROBE BREAK RESPONSE:** If channel is enabled: upscale drive, Input Fault Alarm bit set high, ALM LED illuminates.

CSINI8 SPECIFICATIONS

18. INPUTS:

Channels: 8 single-ended

Ranges: 0-20 mA or 4-20 mA

Effective Resolution: Full 16-bit

Programmable Scaling: \pm 30,000

Linearizer: 100 Points (CSINI8L0 only)

Sample Time: 50 msec - 400 msec, depending on number of enabled inputs.

ENABLED INPUTS	SCAN TIME (READING RATE)
1	50 msec (20 Hz)
2	100 msec (10 Hz)
3	150 msec (6.7 Hz)
4	200 msec (5 Hz)
5	250 msec (4 Hz)
6	300 msec (3.3 Hz)
7	350 msec (2.9 Hz)
8	400 msec (2.5 Hz)

Common Mode Rejection: >110 dB, 50/60 Hz

Normal Mode Rejection: >90 dB, 50/60 Hz

Step Response Time: One scan time (to within 99% of final value)

Input Impedance: 10 Ω

Max. Continuous Overload: 100 mA

19. **ACCURACY:** \pm 0.1% of span

20. **INPUT FAULT RESPONSE:** Upscale Drive, Input Fault Alarm bit set high, ALM LED illuminates below -3 mA, and above 23 mA for 0-20 mA range; below +3 mA and above 23 mA for 4-20 mA signals.

CSINV8 SPECIFICATIONS

21. INPUTS:

Channels: 8 single-ended

Ranges: 0-10 VDC or \pm 10 VDC

Effective Resolution: Full 16-bit

Programmable Scaling: \pm 30,000

Linearizer: 100 Points (CSINV8L0 only)

Sample Time: 50 msec - 400 msec, depending on number of enabled inputs.

ENABLED INPUTS	SCAN TIME (READING RATE)
1	50 msec (20 Hz)
2	100 msec (10 Hz)
3	150 msec (6.7 Hz)
4	200 msec (5 Hz)
5	250 msec (4 Hz)
6	300 msec (3.3 Hz)
7	350 msec (2.9 Hz)
8	400 msec (2.5 Hz)

Common Mode Rejection: >110 dB, 50/60 Hz

Normal Mode Rejection: >90 dB, 50/60 Hz

Step Response Time: One scan time (to within 99% of final value)

Input Impedance: 10 M Ω

Max. Continuous Overload: 50 V

22. **ACCURACY:** \pm 0.1% of span

23. **INPUT FAULT RESPONSE:** Upscale Drive, Input Fault Alarm bit set high, ALM LED illuminates below -10.4 VDC and above +10.4 VDC.

BLOCK DIAGRAM FOR CSTC8, CSRTD6, CSINI8 & CSINV8

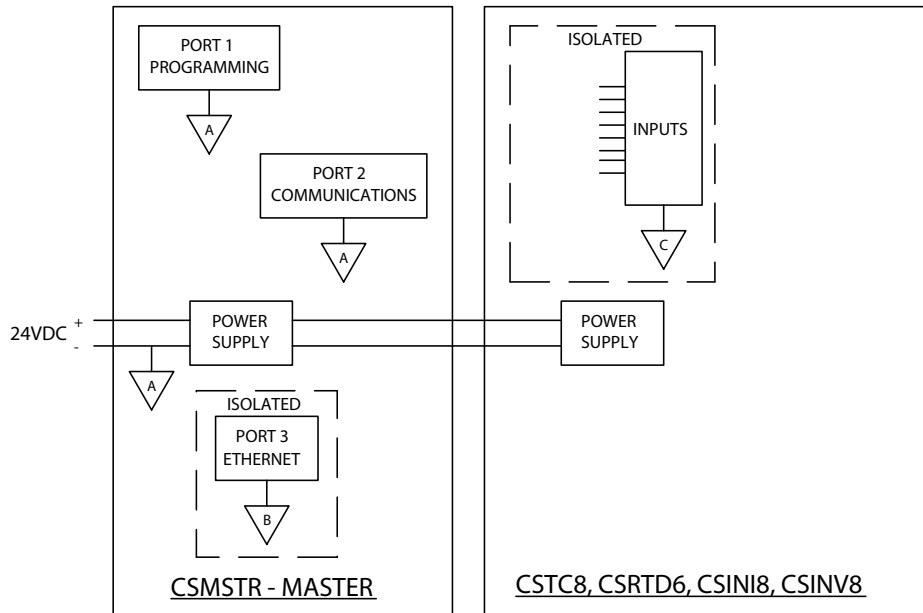

EMC INSTALLATION GUIDELINES

Although Red Lion Controls Products are designed with a high degree of immunity to Electromagnetic Interference (EMI), proper installation and wiring methods must be followed to ensure compatibility in each application. The type of the electrical noise, source or coupling method into a unit may be different for various installations. Cable length, routing, and shield termination are very important and can mean the difference between a successful or troublesome installation. Listed are some EMI guidelines for a successful installation in an industrial environment.

1. A unit should be mounted in a metal enclosure, which is properly connected to protective earth.
2. Use shielded cables for all Signal and Control inputs. The shield connection should be made as short as possible. The connection point for the shield depends somewhat upon the application. Listed below are the recommended methods of connecting the shield, in order of their effectiveness.
 - a. Connect the shield to earth ground (protective earth) at one end where the unit is mounted.
 - b. Connect the shield to earth ground at both ends of the cable, usually when the noise source frequency is over 1 MHz.
3. Never run Signal or Control cables in the same conduit or raceway with AC power lines, conductors, feeding motors, solenoids, SCR controls, and heaters, etc. The cables should be run through metal conduit that is properly grounded. This is especially useful in applications where cable runs are long and portable two-way radios are used in close proximity or if the installation is near a commercial radio transmitter. Also, Signal or Control cables within an enclosure should be routed as far away as possible from contactors, control relays, transformers, and other noisy components.
4. Long cable runs are more susceptible to EMI pickup than short cable runs.
5. In extremely high EMI environments, the use of external EMI suppression devices such as Ferrite Suppression Cores for signal and control cables is effective. The following EMI suppression devices (or equivalent) are recommended:

Fair-Rite part number 0443167251 (RLC part number FCOR0000)
 Line Filters for input power cables:
 Schaffner # FN2010-1/07 (Red Lion Controls # LFIL0000)

6. To protect relay contacts that control inductive loads and to minimize radiated and conducted noise (EMI), some type of contact protection network is normally installed across the load, the contacts or both. The most effective location is across the load.
 - a. Using a snubber, which is a resistor-capacitor (RC) network or metal oxide varistor (MOV) across an AC inductive load is very effective at reducing EMI and increasing relay contact life.
 - b. If a DC inductive load (such as a DC relay coil) is controlled by a transistor switch, care must be taken not to exceed the breakdown voltage of the transistor when the load is switched. One of the most effective ways is to place a diode across the inductive load. Most RLC products with solid state outputs have internal zener diode protection. However external diode protection at the load is always a good design practice to limit EMI. Although the use of a snubber or varistor could be used.
 RLC part numbers: Snubber: SNUB0000
 Varistor: ILS11500 or ILS23000
7. Care should be taken when connecting input and output devices to the instrument. When a separate input and output common is provided, they should not be mixed. Therefore a sensor common should NOT be connected to an output common. This would cause EMI on the sensitive input common, which could affect the instrument's operation.

Visit RLC's web site at <http://www.redlion.net/emi> for more information on EMI guidelines, Safety and CE issues as they relate to Red Lion Controls products.

HARDWARE INSTALLATION

SEPARATE BASE FROM MODULE

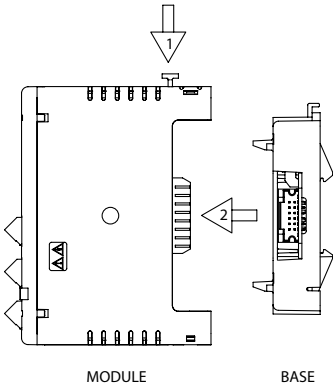

ATTACH THE MODULE BASE TO THE DIN RAIL

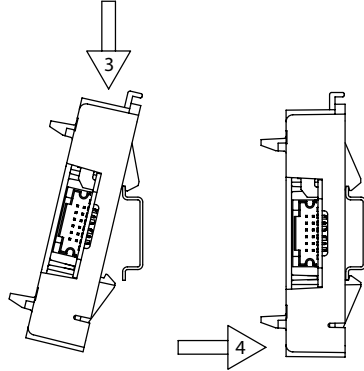

ATTACH MODULE TO BASE

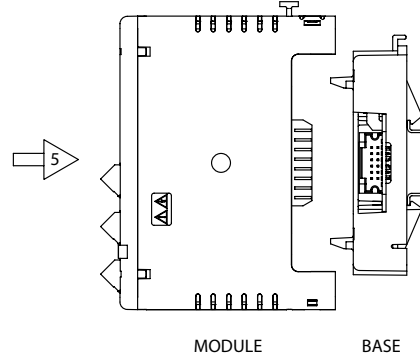

WIRING

WIRING CONNECTIONS

All conductors should meet voltage and current ratings for each terminal. Also, cabling should conform to appropriate standards of good installation, local codes and regulations. When wiring the module, use the numbers on the label to identify the position number with the proper function. Strip the wire, leaving approximately 1/4" (6 mm) of bare wire exposed. Insert the wire into the terminal, and tighten.

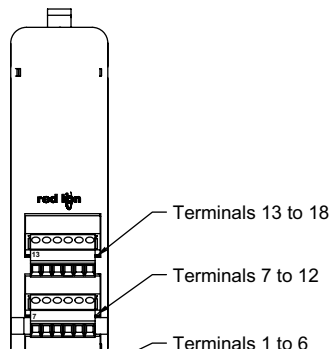

WARNING - EXPLOSION HAZARD - DO NOT DISCONNECT WHILE CIRCUIT IS ALIVE UNLESS AREA IS KNOWN TO BE NON-HAZARDOUS.

INPUT AND OUTPUT (I/O) WIRING MUST BE IN ACCORDANCE WITH CLASS I, DIV. 2 WIRING METHODS AND IN ACCORDANCE WITH THE AUTHORITY HAVING JURISDICTION.

INPUT CONNECTIONS

CSTC

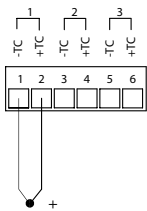
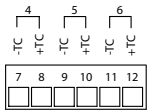
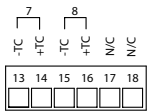

CSRTD

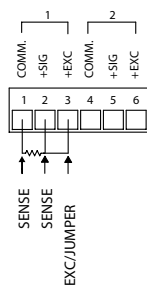
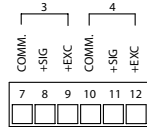
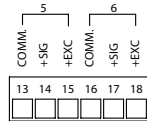

CSINI

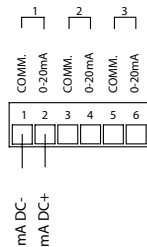
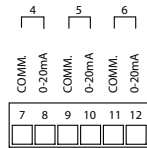
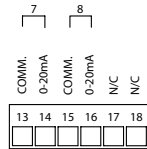

CSINV

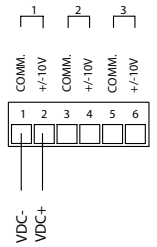
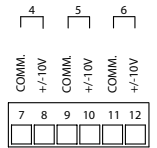
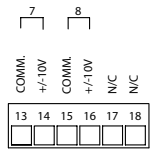

LEDS

STS – STATUS LED

The Status LED is a dual color LED that provides information regarding the state of the module. This includes indication of the various stages of the start-up routine (power-up), as well as any errors that may occur.

Startup Routine

Rapidly Flashing Red	Module is currently running the boot loader and/or being flash upgraded by Crimson. This occurs for four seconds during a power up.
Steady Red	Module switching to configuration.
Green	Module performing normally.

FIRMWARE UPGRADE

The module's firmware is stored in flash memory so that software/hardware conflicts are avoided, and so that software features may be added in the future.

During a download, Crimson compares its own library of firmware files with those stored in the Master module. If they do not match, Crimson will download the necessary files. The Master then checks to make sure that the I/O modules contain the same firmware. If they contain a different revision, the Master will automatically copy those files into the module's flash memory. During this process, the module LEDs will flash rapidly, starting with the top row, and progressing through the remaining rows until the process is complete.

Error States

Solid Red	Module not controlling, and not communicating.
Green/Pulsing Red	Module is controlling properly, but has lost communication with the Master.

ALM – ALARM LED

The Alarm LED indicates the presence of an input fault condition. When one or more Input Fault Alarm bits is high, the LED turns on. The alarms may be disabled for unused inputs.

CONFIGURATION

Programming is done via Crimson[®] software, a Windows[®] compatible configuration interface. Please see the Crimson manual for more information.

ORDERING INFORMATION

TYPE	MODEL NO.	DESCRIPTION	PART NUMBER
Master Module	CSMSTR	Modular Controller Master, Multi Comms ports and Ethernet	CSMSTRV2
		Modular Controller Master with multiple protocol converter, data logger, web server with Virtual HMI up to QVGA (320 x 240) size and expansion slot.	CSMSTRSX
		Modular Controller Master with multiple protocol converter, data logger, web server with Virtual HMI up to VGA (640 x 480) size and expansion slot with increased SDRAM	CSMSTRGT
Input Modules	CSTC ¹	8 Channel Thermocouple Module	CSTC8000
	CSINI	8 Channel 0(4)-20 mA Input Module	CSINI800
		8 Channel 0(4)-20 mA Input Module, 100-Point Linearizer	CSINI8L0
	CSINV	8 Channel ±10 V Input Module	CSINV800
		8 Channel ±10 V Input Module, 100-Point Linearizer	CSINV8L0
CSRTD	6 Channel RTD Module	CSRTD600	
Communications Cables (10 feet)	CBL	Programming Cable for CS, G3, & Paradigm Series	CBLPROG0
		Communications Cables ¹	CBLxxxx
Software		Crimson [®] Programming Software ²	SFCRM
		Crimson [®] Programming Software, Manual, and Download Cable	SFCRK
Accessories		Rail Stops (Qty 2)	RSRSTP00
		Replacement Base	CSBASE00
		Replacement Termination Plug	CSTERM00

Note: Certain modules are not suitable for use in Hazardous locations. Check each module's specifications prior to installation.

¹ Visit www.redlion.net for a complete list of PID modules, data acquisition modules, communications drivers and cables.

² Free at www.redlion.net

This page intentionally left blank

LIMITED WARRANTY

The Company warrants the products it manufactures against defects in materials and workmanship for a period limited to two years from the date of shipment, provided the products have been stored, handled, installed, and used under proper conditions. The Company's liability under this limited warranty shall extend only to the repair or replacement of a defective product, at The Company's option. The Company disclaims all liability for any affirmation, promise or representation with respect to the products.

The customer agrees to hold Red Lion Controls harmless from, defend, and indemnify RLC against damages, claims, and expenses arising out of subsequent sales of RLC products or products containing components manufactured by RLC and based upon personal injuries, deaths, property damage, lost profits, and other matters which Buyer, its employees, or sub-contractors are or may be to any extent liable, including without limitation penalties imposed by the Consumer Product Safety Act (P.L. 92-573) and liability imposed upon any person pursuant to the Magnuson-Moss Warranty Act (P.L. 93-637), as now in effect or as amended hereafter.

No warranties expressed or implied are created with respect to The Company's products except those expressly contained herein. The Customer acknowledges the disclaimers and limitations contained herein and relies on no other warranties or affirmations.